

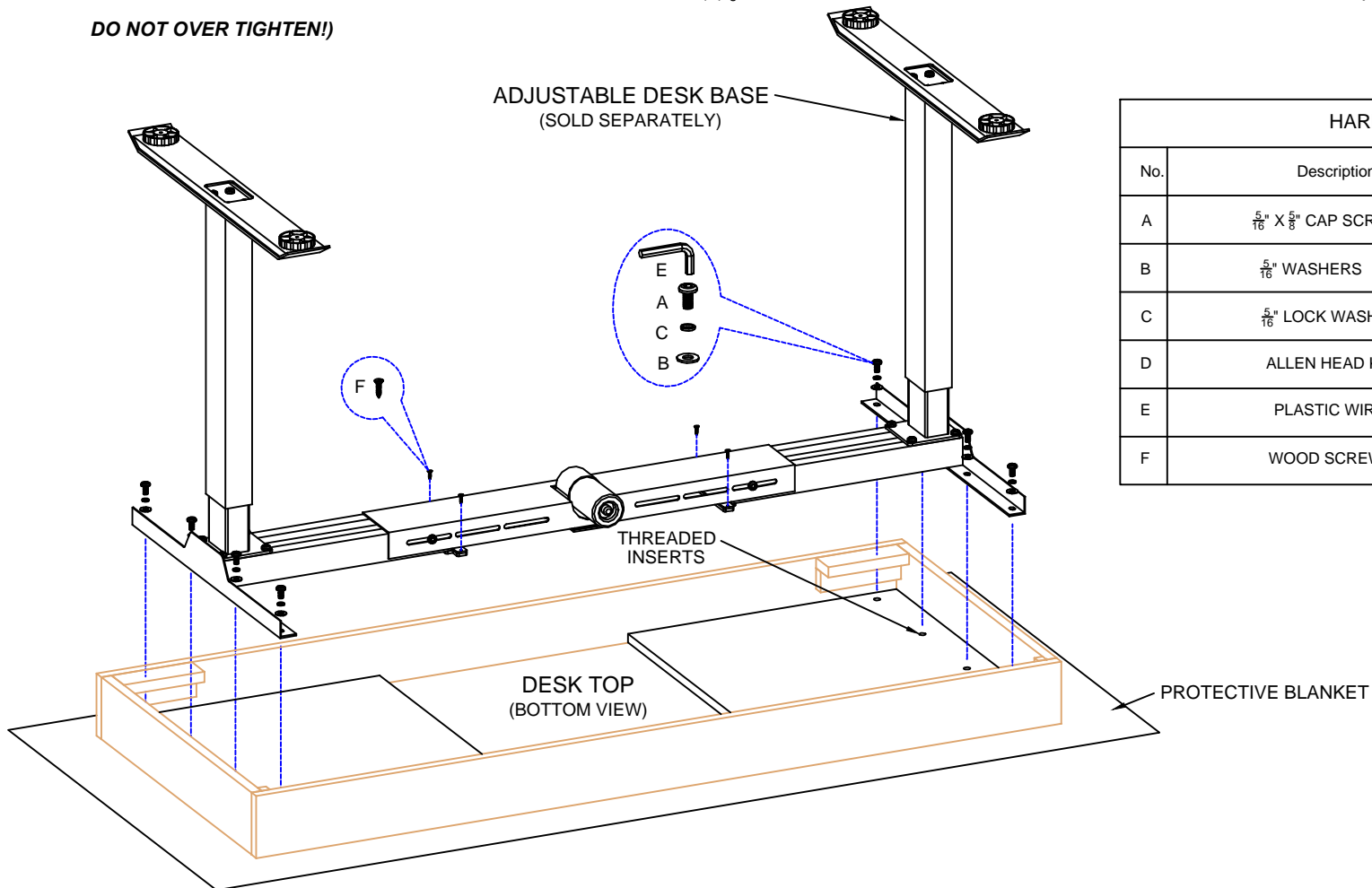





LIFT DESK ASSEMBLY INSTRUCTIONS FOR LIFT MECHANISM MODEL # IUAB-301-1

74-1

ATTACHING ADJUSTABLE DESK BASE TO DESK TOP

1. TO AVOID SCRATCHING DESK TOP & FLOOR SURFACE, BEFORE OPENING BOXES, PLACE A PROTECTIVE BLANKET DOWN.
2. UN-BOX THE ADJUSTABLE DESK BASE AND FOLLOW THE ASSEMBLY INSTRUCTIONS PROVIDED
3. UN-BOX DESK TOP AND WITH THE AID OF A SECOND PERSON, ROTATE DESK TOP AND PLACE ONTO BLANKET.
4. WITH THE AID OF A SECOND PERSON, ROTATE ADJUSTABLE DESK BASE, PLACE IT ON BOTTOM OF DESK TOP AND LINE UP ADJUSTABLE DESK BASE HOLES WITH DESK TOP INSERTS (FOR ADJUSTING DESK BASE WIDTH READ ASSEMBLY INSTRUCTIONS PROVIDED)
5. SECURE ADJUSTABLE DESK BASE TO DESK TOP USING THE (8) $\frac{5}{16}$ " CAP SCREWS PROVIDED IN THIS DESK TOP HARDWARE PACK. (**TIGHTEN CAP SCREWS UNTIL SNUG, DO NOT OVER TIGHTEN!**)



HARDWARE LIST			
No.	Description	Sketch	Quantity
A	$\frac{5}{16}$ " X $\frac{5}{8}$ " CAP SCREWS		8 PCS
B	$\frac{5}{16}$ " WASHERS		8 PCS
C	$\frac{5}{16}$ " LOCK WASHERS		8 PCS
D	ALLEN HEAD KEY		1 PCS
E	PLASTIC WIRE CLIPS		6 PCS
F	WOOD SCREWS		10 PCS

LIFT DESK ASSEMBLY INSTRUCTIONS FOR LIFT MECHANISM MODEL # IUAB-301-1

74-1

- ATTACH ADJUSTABLE DESK BASE CONTROL UNIT TO EITHER THE RIGHT OR LEFT HARDWOOD CORNER BLOCK (SCREWS PROVIDED WITH ADJUSTABLE DESK BASE)
- CLIP THE POWER CORD INTO THE (6) PLASTIC WIRE CLIPS AND SCREW WIRE CLIPS TO THE RIGHT & LEFT THREADED INSERT PANELS (**DO NOT SCREW WIRE CLIPS INTO DESK TOP**)
- WITH THE AID OF A SECOND PERSON, LIFT & ROTATE DESK TO IT'S UPRIGHT POSITION.
- HOOK METAL POWER PACK SUPPORT TRAY TO CENTER CHANNEL, PLACE POWER PACK IN TRAY (FOR PLUGGING IN POWER CORDS, REFER TO ADJUSTABLE BASE DESK INSTRUCTIONS).
- PLUG IN MOTOR & CONTROL UNIT INTO POWER PACK CORD INTO AC OUTLET.
- IF DISASSEMBLY IS REQUIRED, LOWER ADJUSTABLE DESK BASE TO THE LOWEST POINT.

