











ASSEMBLY INSTRUCTIONS





aspenhome®

Distributed by Furniture Values International, LLC

ITEM NO:I24-366-1 Chair

Step	Code	Hardware	Q'TY
2	A	Bolt 5/16"*18*4-1/2" 	4 Pcs
2	B	Bolt 5/16"*18*1-3/4" 	2 Pcs
2	C	Spring Washer 5/16" 	6 Pcs
2	D	Flat Washer 5/16"*19mm*2 mm 	6 Pcs
2	E	Allen Key 5mm 	1 Pc
2	F	Nut 	4 Pcs
2	G	Hex Wrench 	1 Pc
3	H	Bolt 3/8"*18*1-1/4" 	4 Pcs
3	I	Spring Washer 3/8" 	4 Pcs
3	J	Flat Washer 3/8"*22mm*2mm 	4 Pcs
3	K	Allen Key 4mm 	1 Pc

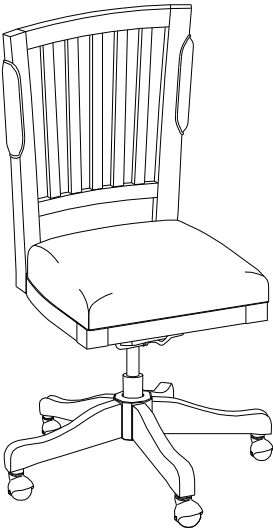
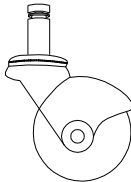
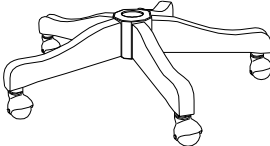
Parts Identification

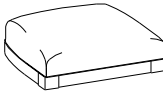
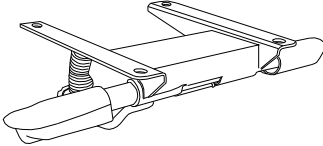
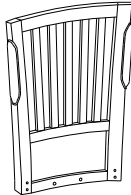
	 <p>L. 5 Casters</p>	 <p>O. Wooden base</p>
	 <p>M. Pneumatic cylinder</p>	 <p>P. Seating</p>
	 <p>N. Seat Plate</p>	 <p>Q. Chair back</p>

ASSEMBLY INSTRUCTIONS



aspenhome[®]

Distributed by Furniture Values International, LLC



BEFORE USING THIS PRODUCT, READ, UNDERSTAND, AND FOLLOW THESE INSTRUCTIONS.

Save these instructions for future reference.

FOR INDOOR USE ONLY

IMPORTANT SAFEGUARDS

• Read all instructions before use.

- This product is intended for use as a seat for adults. Do not use the product for any other purpose.
- This product is not a toy. Keep the product away from children and pets.
- Always place the product on a flat, stable surface.
- Do not place the product near heat or open flames.
- Do not set heavy objects on the product.
- Never stand on the product or use it as a stepladder.
- To avoid a possible pinch hazard, never insert fingers, hands, or other body parts in between the product hinges and joints, especially when assembling or disassembling the product.
- Ensure all parts are securely attached before use. Periodically check the parts to ensure they are securely in place.
- We will not be responsible for any injury or death resulting from the improper use or care of this chair.

SAVE THESE INSTRUCTIONS FOR FUTURE REFERENCE

ASSEMBLY INSTRUCTIONS

ah

aspenhome®

Distributed by Furniture Values International, LLC

To Assemble

1. Insert the Pneumatic Cylinder (M) through the center hole on top of the Wooden base (O).

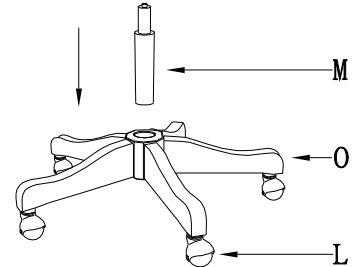

2. Attach Seating (P) to Chair back (Q) by using bolts (A) and bolts (B), use Allen key (E) and hex wrench (G) tighten all bolts.

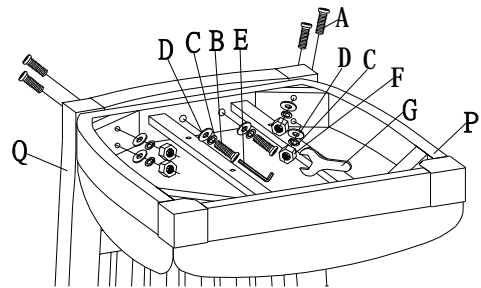

3. Attach the Seat Plate (N) to the Seating (P) Using the 4 Screws (H). Do not tighten fully.

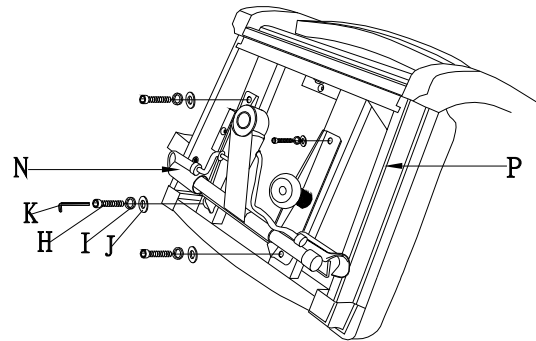

4. Insert the Seating Unit (Q) (P) onto the Pneumatic Cylinder (M). Push firmly on the chair seat to securely attach the Seating Unit (Q) (P) onto the Pneumatic cylinder (M)

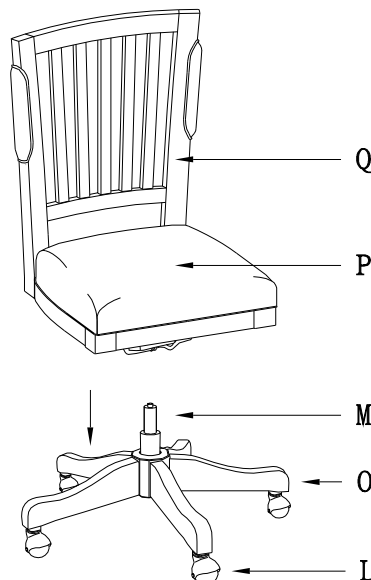

ASSEMBLY INSTRUCTIONS



aspenhome[®]

Distributed by Furniture Values International, LLC

To Adjust

Height Adjustment:

To raise the seat height, remove weight from the seat and pull up on the Height Adjustment Lever.

To lower the seat height, while seated pull up slowly on the Height Adjustment Lever until the seat is at the desired height.

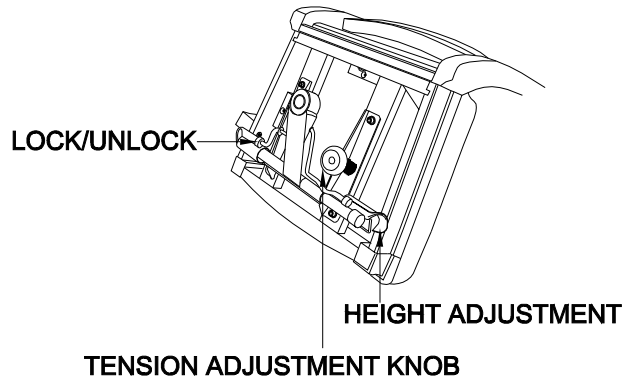

Seat Tilt Tension Adjustment:

To adjust the seat tilt tension, turn the Tension Adjustment Knob on the underside of the seat to the desired tension.

To lock tilt function, slide the Lock/Unlock Lever in toward center of chair.

To unlock tilt function, pull Lock/Unlock Lever outward.

WARNING: To avoid possible personal injury, ensure all screws are fully tightened before using the chair. Periodically check the screws and ensure that they remain fully tightened.

Care and Maintenance

- Check and securely tighten all product parts (hinges, bolts, screws, etc.) before each use.
- Inspect the product for wear and tear, rust, or cracked, broken, unstable parts before each use. Do not use the product if it is damaged or if the parts show any signs of instability or abnormal wear.
- Inspect the seat and seat back. If they are not intact or are damaged, permanently discontinue use of this product.
- Dust the leather part of the chair with a soft cloth. If leather becomes soiled, use a leather cleaner (follow the instructions for the cleaner).
- Clean all non-leather parts of the chair with a soft cloth.