

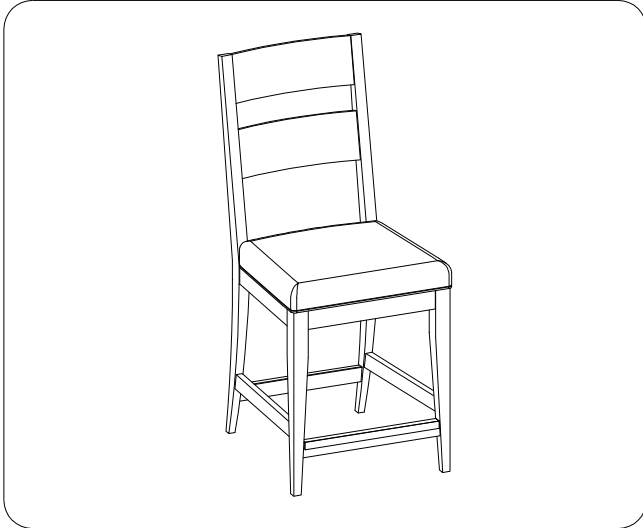















ITEM NO: I256-6643S Counter Height Side Chair w/ Uph Seat (2/Ctn)

Thank you for purchasing this quality product. Be sure to check all packing material carefully for small parts that may come loose inside the carton during shipment.

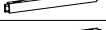

TOOLS REQUIRED (NOT PROVIDED)
PHILLIPS SCREWDRIVER 

HARDWARE LIST:			
No.	Description	Sketch	Quantity
A	Hex Bolt Ø5/16" x 2-3/4"		4 PCS
B	Hex Bolt Ø5/16" x 1-3/4"		1 PC
C	Hex Nut Ø5/16"		4 PCS
D	Lock Washer Ø5/16"		9 PCS
E	Flat Washer Ø5/16" x 3/4"		9 PCS
F	Hex Wrench 12mm		1 PC
G	Wood Screw #4 x 2"		6 PCS

COMPONENTS LIST:			
No.	Description	Sketch	Quantity
1	Chair Back		1 PC
2	Chair Seat		1 PC
3	Left Front Leg		1 PC
4	Right Front Leg		1 PC
5	Front Stretcher		1 PC
6	Left Side Stretcher		1 PC
7	Right Side Stretcher		1 PC

FUNCTIONALITY INSTRUCTION

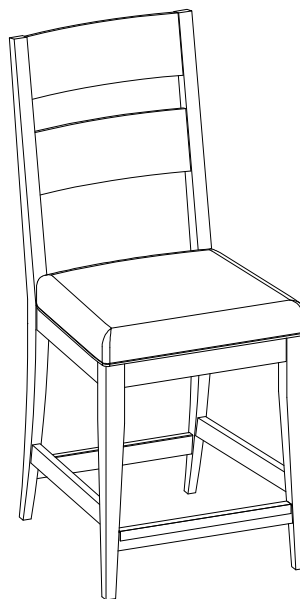

BEFORE USING THIS PRODUCT PLEASE READ, UNDERSTAND, AND FOLLOW THESE INSTRUCTIONS.
Save these instructions for future reference.

FOR INDOOR USE ONLY

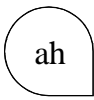

ITEM NO: I256-6643S Counter Height Side Chair w/ Uph Seat (2/Ctn)

STEP 1: Assemble the right front leg and the left front leg with front stretcher by screws(G). Making sure the drill holes on each front leg and the chamfers on all legs are aligned as shown right.

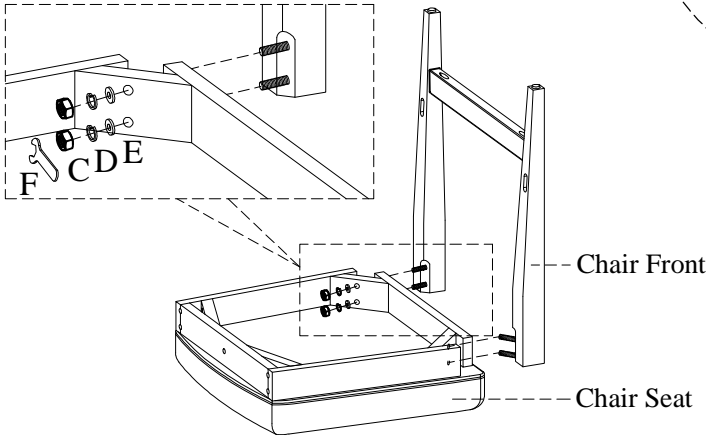
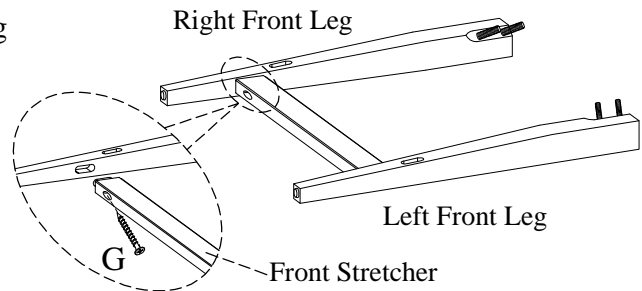

STEP 2: Attach the assembled chair front to chair seat by using 4 flat washers(E), lock washers(D), and hex nuts(C) with a hex wrench(F), Do not tighten bolts until STEP 4.

STEP 3: Attach the chair seat to chair back by using 4 bolts(A), 1 bolt(B), 5 lock washers(D), 5 flat washers(E) with a hex wrench(F) Do not completely tighten bolts.

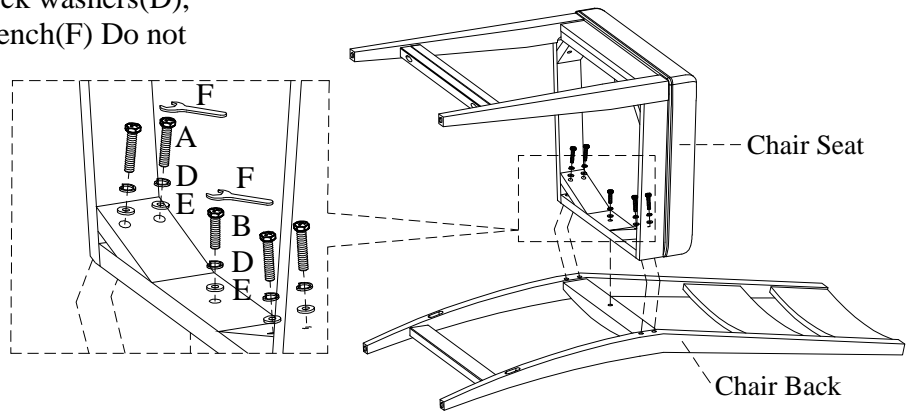

Right Side Stretcher

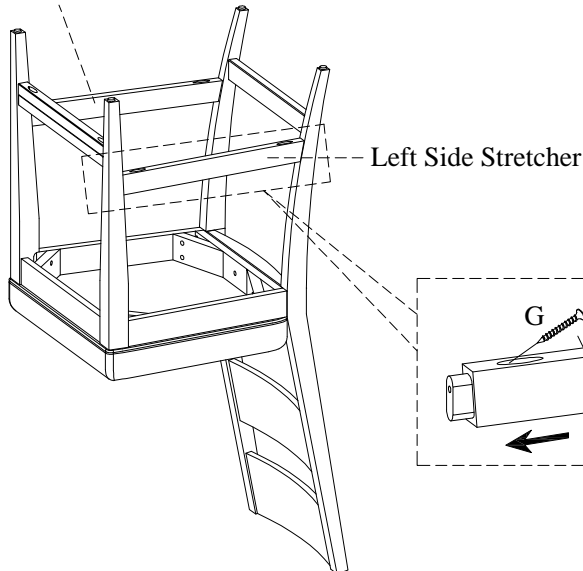

STEP 4: Attach the left side stretcher and right side stretcher to the front legs and chair back with wood screws(G). Completely tighten all wood screws and bolts. Turn the assembled chair to the upright position.

