

ITEM NO: I3014-332 Door Bookcase

Thank you for purchasing this quality product. Be sure to check all packing material carefully for small parts that may come loose inside the carton during shipment.

WARNING! Before using this product, please read, understand, and follow these instructions. Failure to follow each of these assembly instructions precisely may result in damage to the product and / or injury to the consumer.





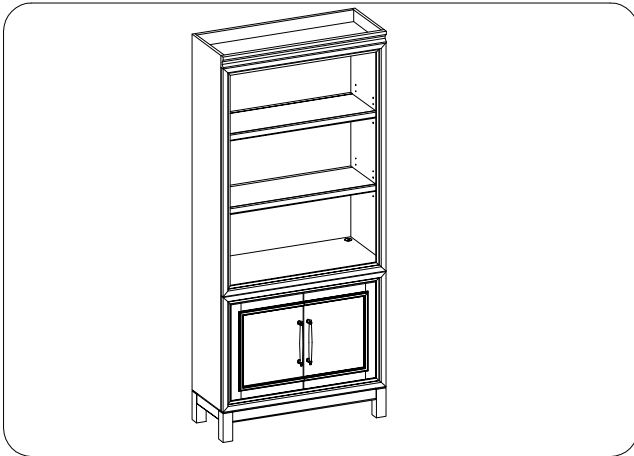



UNIT SHOULD BE INSTALLED BY 2 OR MORE PERSONS.





TOOLS REQUIRED (NOT PROVIDED)

PHILLIPS SCREWDRIVER 

COMPONENTS LIST:

No.	Description	Sketch	Quantity
A	Bolt Ø5/16" x 2"		8 PCS
B	Lock Washer Ø5/16"		8 PCS
C	Flat Washer Ø5/16" x 3/4"		8 PCS
D	Allen Wrench 4mm		1 PC
E	U Shape Bracket		2 PCS
F	Wood Screw #8 x 5/8"		4 PCS

COMPONENTS LIST:

No.	Description	Sketch	Quantity
1	Case		1 PC
2	Leg		4 PCS

FUNCTIONALITY INSTRUCTION

U Shape Bracket

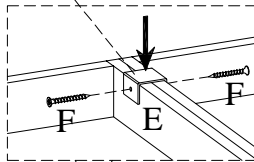

Attach the U shape brackets (E) to the top of the bookcase with the screws (F).

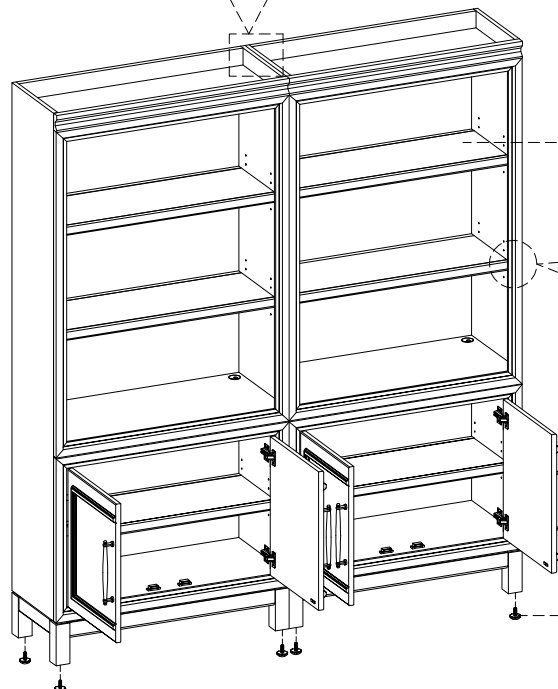

Adjustable Wood Shelves

If you prefer to adjust the shelf location, remove the screws and move shelf brackets to the desired location. Then secure the brackets to shelf with screws.

Leveler on Legs

Adjust the leveler when necessary

FOR INDOOR USE ONLY



ITEM NO: I3014-332 Door Bookcase

STEP 1: Put the case backside down on a soft surface.

STEP 2: Attach the legs to the bottom of case by using 8 bolts(A), lock washers(B), flat washers(C) with the allen wrench(D). Completely tighten all bolts.

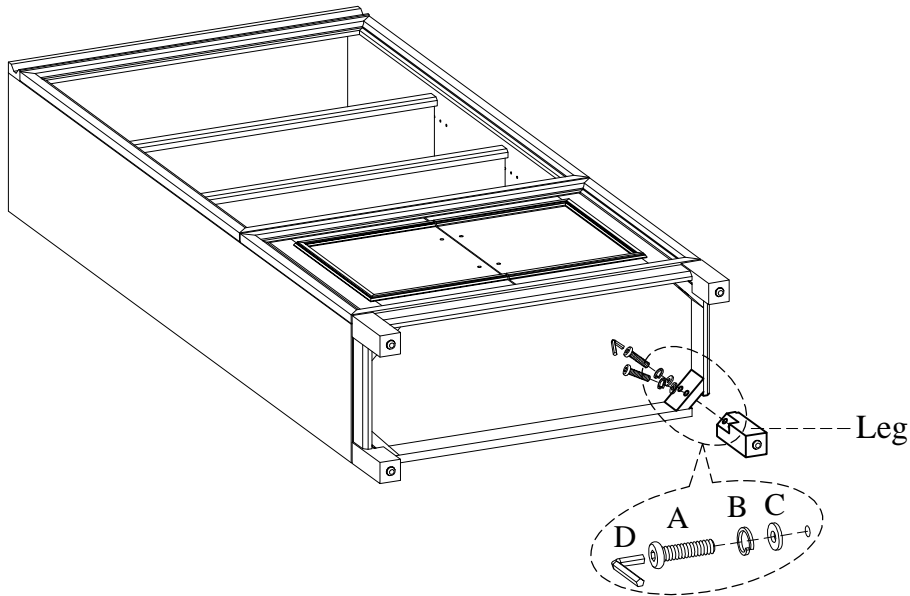

STEP 3: Return the assembled case to the upright position.

STEP 4: Reverse the handles by removing the screws while each door is open and attach the handles to the front of the door with screws as shown below.

