

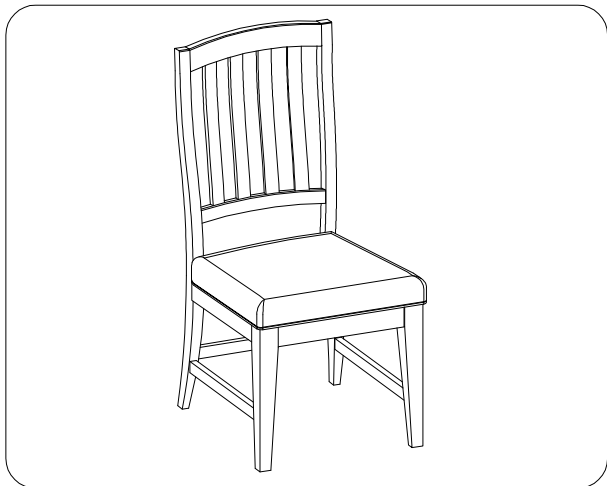

















ITEM NO: I349-6640S-WST Dining Side Chair w/ Uph Seat (2/Ctn)

Thank you for purchasing this quality product. Be sure to check all packing material carefully for small parts that may come loose inside the carton during shipment.



TOOLS REQUIRED (NOT PROVIDED)
PHILLIPS SCREWDRIVER 

HARDWARE LIST:			
No.	Description	Sketch	Quantity
A	Hex Nut Ø5/16"		4 PCS
B	Bolt Ø5/16" x 3-1/2"(18)		4 PCS
C	Bolt Ø5/16" x 1-1/2"(18)		3 PCS
D	Lock Washer Ø5/16"		11 PCS
E	Flat Washer Ø5/16" x 3/4"		11 PCS
F	Allen Wrench 4mm		1 PC
G	Hex Wrench 12mm		1 PC
H	Wood Screw #4 x 1-1/2"		4 PCS

COMPONENTS LIST:			
No.	Description	Sketch	Quantity
1	Chair Back		1 PC
2	Chair Seat		1 PC
3	Left Front Leg		1 PC
4	Right Front Leg		1 PC
5	Left Side Stretcher		1 PC
6	Right Side Stretcher		1 PC

FUNCTIONALITY INSTRUCTION

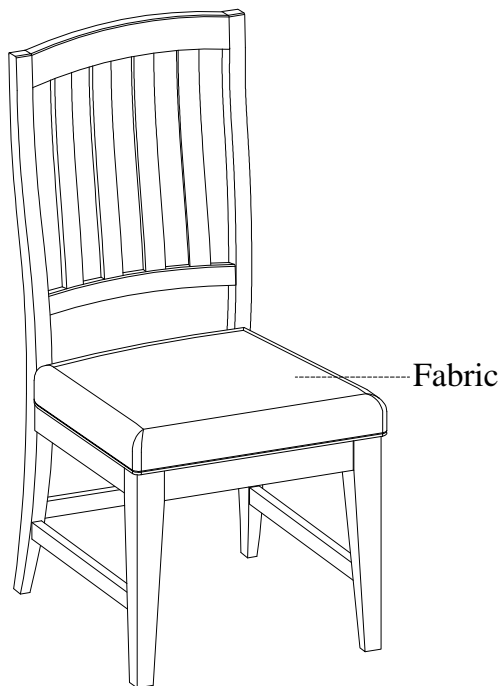

BEFORE USING THIS PRODUCT PLEASE READ, UNDERSTAND, AND FOLLOW THESE INSTRUCTIONS. Save these instructions for future reference.

FOR INDOOR USE ONLY



ITEM NO: I349-6640S-WST

Dining Side Chair w/ Uph Seat (2/Ctn)

STEP 1: Attach the chair seat to chair back by using 4 bolts(B), 3 bolts(C), 7 lock washers(D), 7 flat washers(E) with an allen wrench(F), Do not completely tighten bolts.

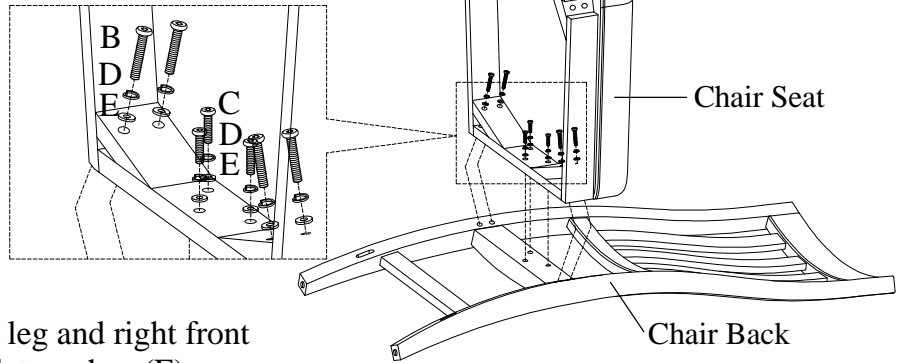

STEP 2: Attach the left front leg and right front leg to chair seat by using 4 flat washers(E), lock washers(D) and hex nut(A) with a hex wrench(G), Do not tighten bolts until STEP 3.

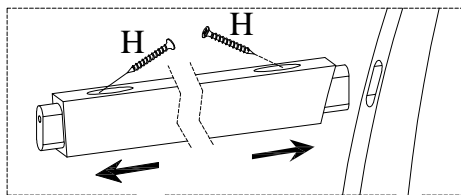
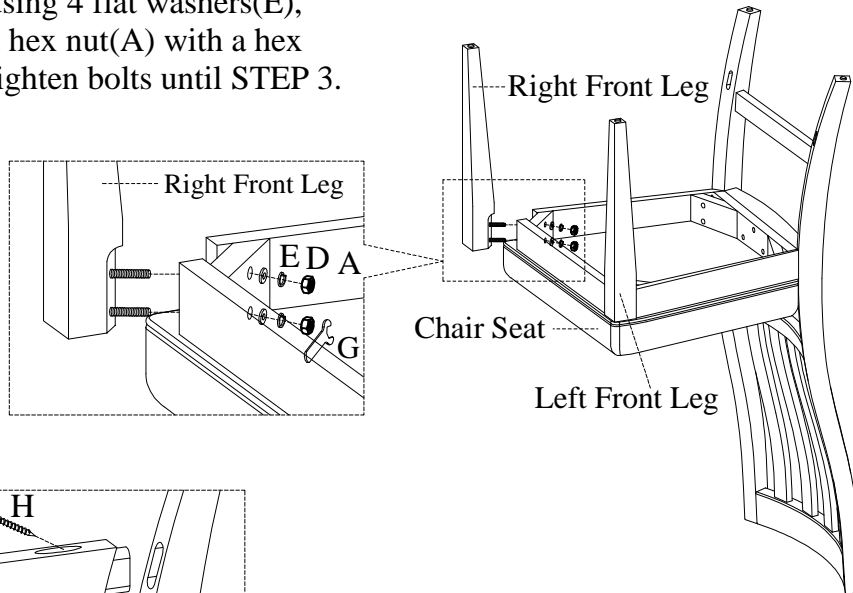

STEP 3: Attach the left side stretcher and right side stretcher to the front legs and chair back with wood screws(H). Completely tighten all wood screws and bolts. Turn the assembled chair to the upright position.

