

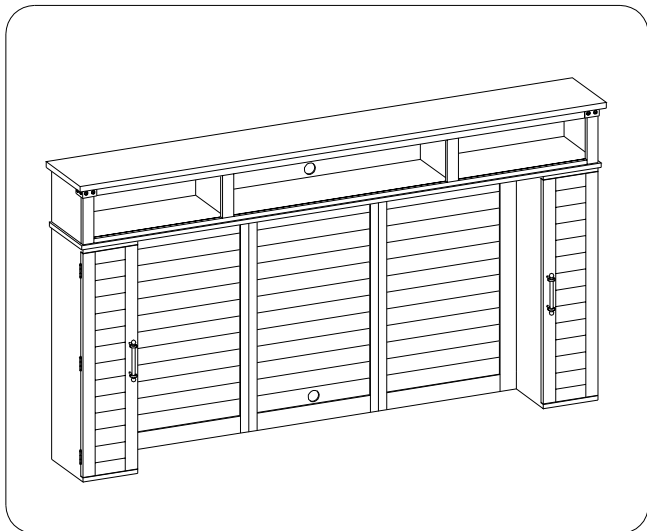

ITEM NO: I349-297H-WST 96" Hutch







Thank you for purchasing this quality product. Be sure to check all packing material carefully for small parts that may come loose inside the carton during shipment.









TOOLS REQUIRED (NOT PROVIDED)

PHILLIPS SCREWDRIVER 

HARDWARE LIST:

| No. | Description | Sketch | Quantity |
|-----|--------------------------|---|----------|
| A | Bolt Ø1/4" x 1-3/4" (20) |  | 20 PCS |
| B | Bolt Ø1/4" x 3/4" (20) |  | 8 PCS |
| C | Lock Washer Ø1/4" |  | 28 PCS |
| D | Flat Washer Ø1/4" x 3/4" |  | 28 PCS |
| E | Allen Wrench 4mm |  | 1 PC |
| F | Wood Screw #4 x 1-1/4" |  | 16 PCS |
| G | Metal Plate |  | 4 PCS |

COMPONENTS LIST:

| No. | Description | Sketch | Quantity |
|-----|---------------------|---|----------|
| 1 | Top Assembly |  | 1 PC |
| 2 | Left Pedestal |  | 1 PC |
| 3 | Right Pedestal |  | 1 PC |
| 4 | Back Panel (Left) |  | 1 PC |
| 5 | Back Panel (Middle) |  | 1 PC |
| 6 | Back Panel (Right) |  | 1 PC |

FUNCTIONALITY INSTRUCTION

I349-297H

I349-297

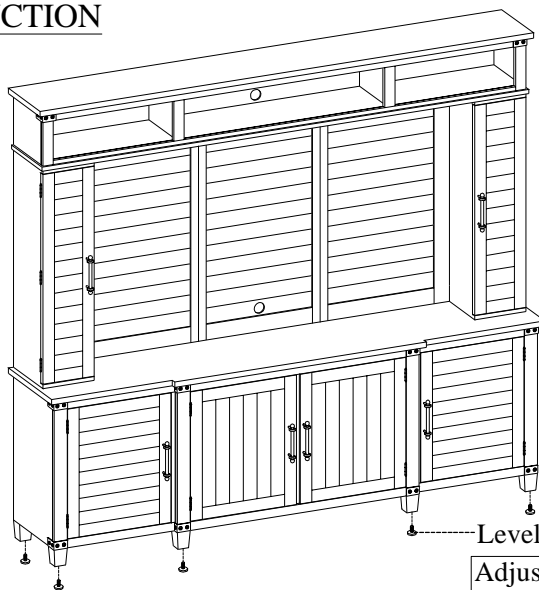

Leveler on Legs & Support Leg

Adjust the leveler when necessary

BEFORE USING THIS PRODUCT PLEASE READ, UNDERSTAND, AND FOLLOW THESE INSTRUCTIONS. Save these instructions for future reference.

FOR INDOOR USE ONLY



ITEM NO: I349-297H-WST 96" Hutch

STEP 1: Attach the back panels (left & right) to the back panel (middle) using 6 bolts (A), lock washers (C) and flat washers (D) as shown below. Do not completely tighten bolts.

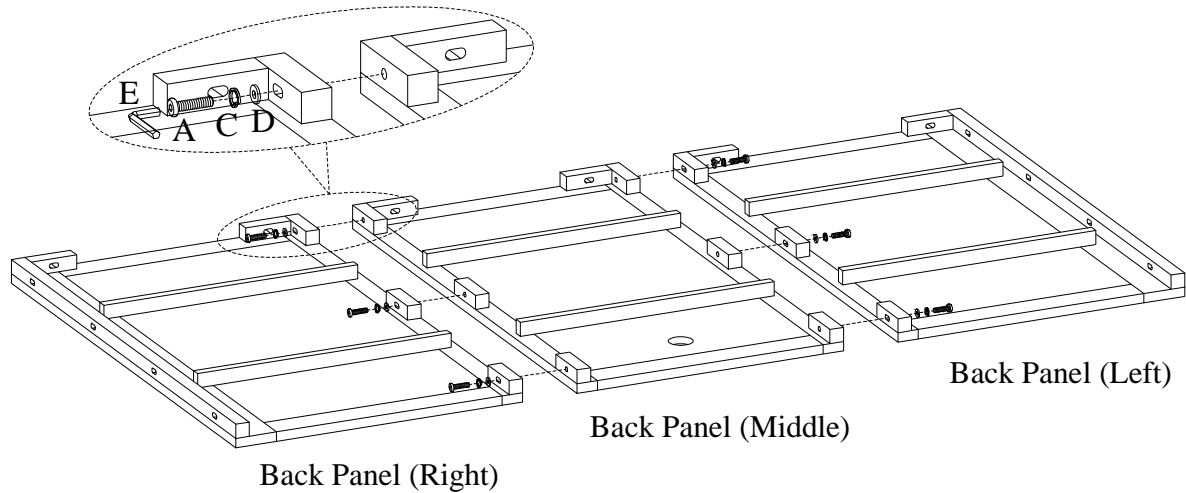

STEP 2: Attach the back panel assembly to the left pedestal and right pedestal by using 8 bolts (A), lock washers (C) and flat washers (D). Do not tighten the bolts completely.

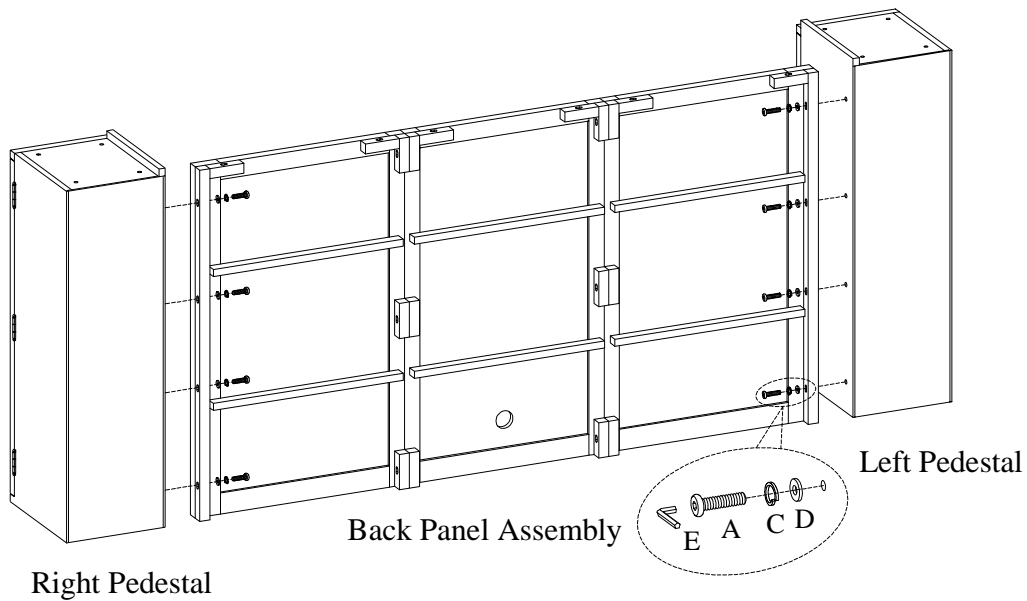

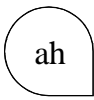

ITEM NO: I349-297H-WST 96" Hutch

STEP 3-1: Attach the top assembly to the pedestal assembly using 8 bolts (B), 6 bolts (A), lock washers (C) and flat washers (D). Completely tighten all bolts.

STEP 3-2: Reverse each handle by removing the screws while each door is open and attach all handles to the front of the doors with screws as shown below.

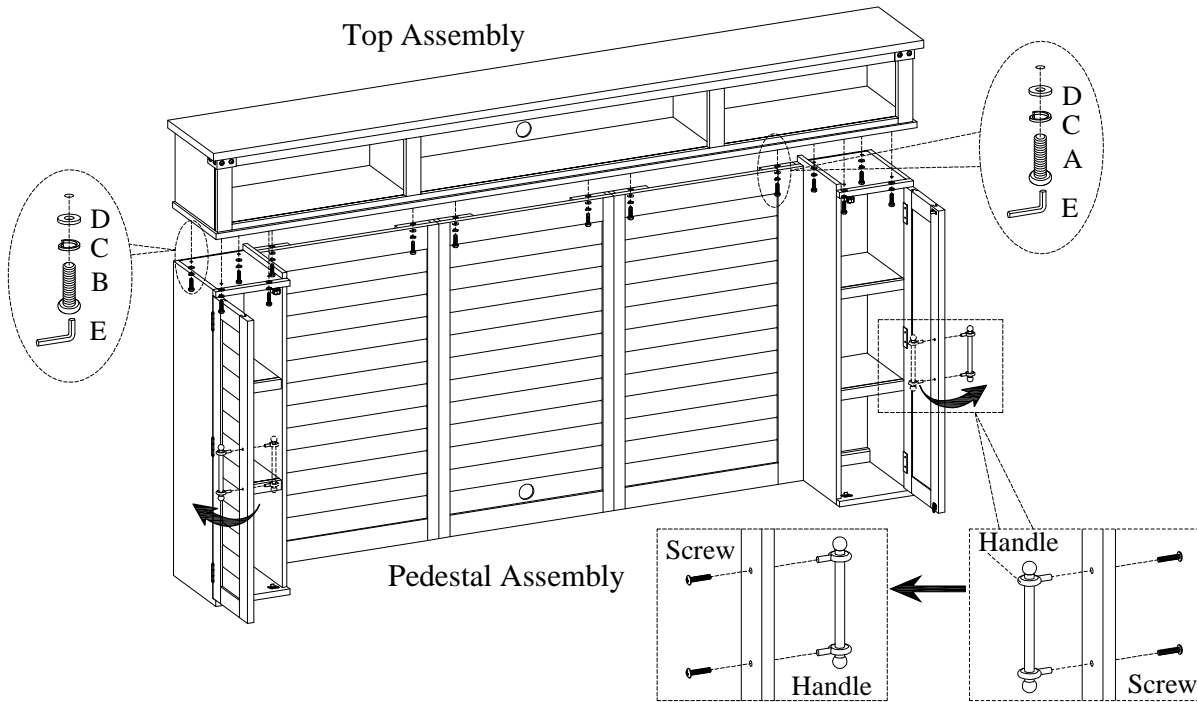

STEP 4: Position the hutch on the console. Attach the metal plates(G) to the back of hutch & console with wood screws(F) as shown below.

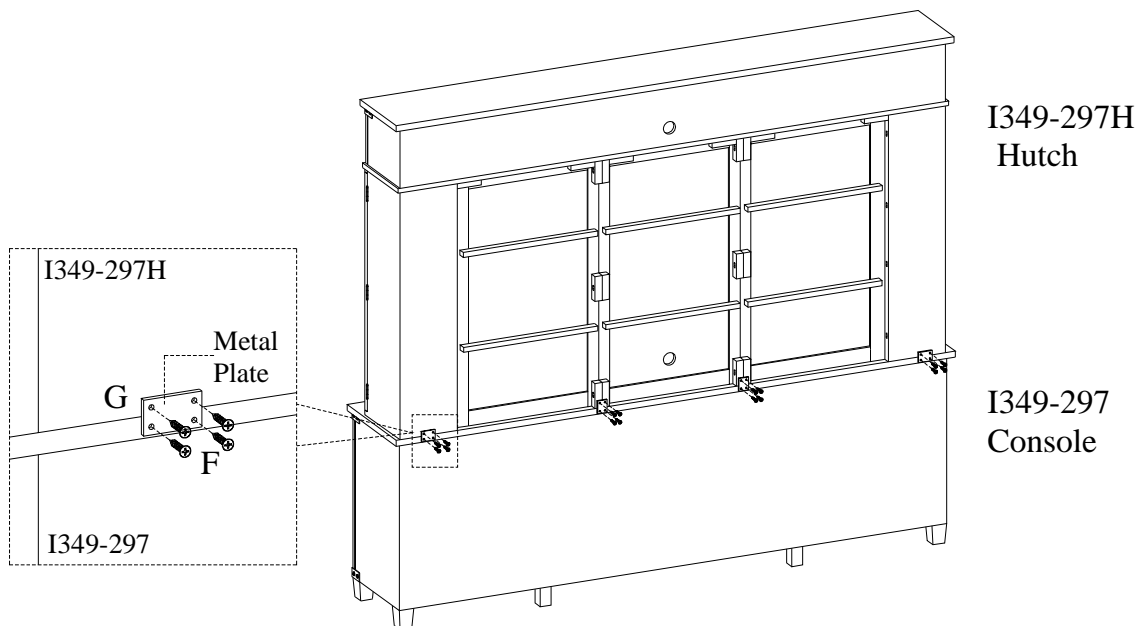

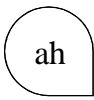

ITEM NO: I349-297-WST 96" Console

Thank you for purchasing this quality product. Be sure to check all packing material carefully for small parts that may come loose inside the carton during shipment.

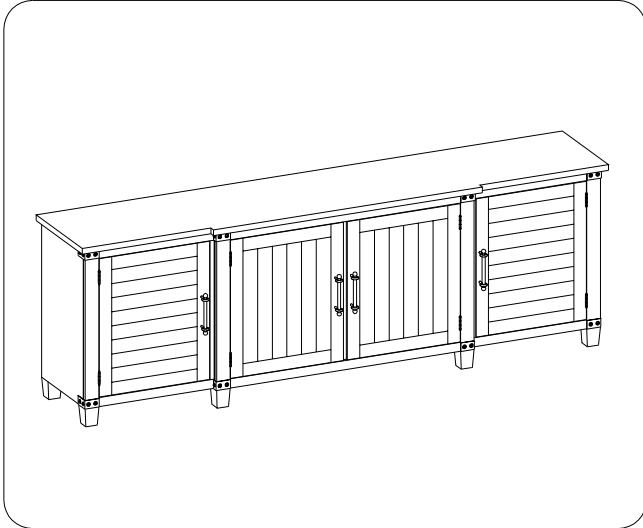

TOOLS REQUIRED (NOT PROVIDED)

PHILLIPS SCREWDRIVER 

STEP 1: Reverse each handle by removing the screws while opening each door in the middle and attach all handles to the front of middle doors with screws as shown below.

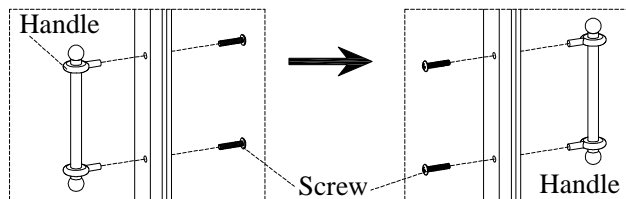

FUNCTIONALITY INSTRUCTION

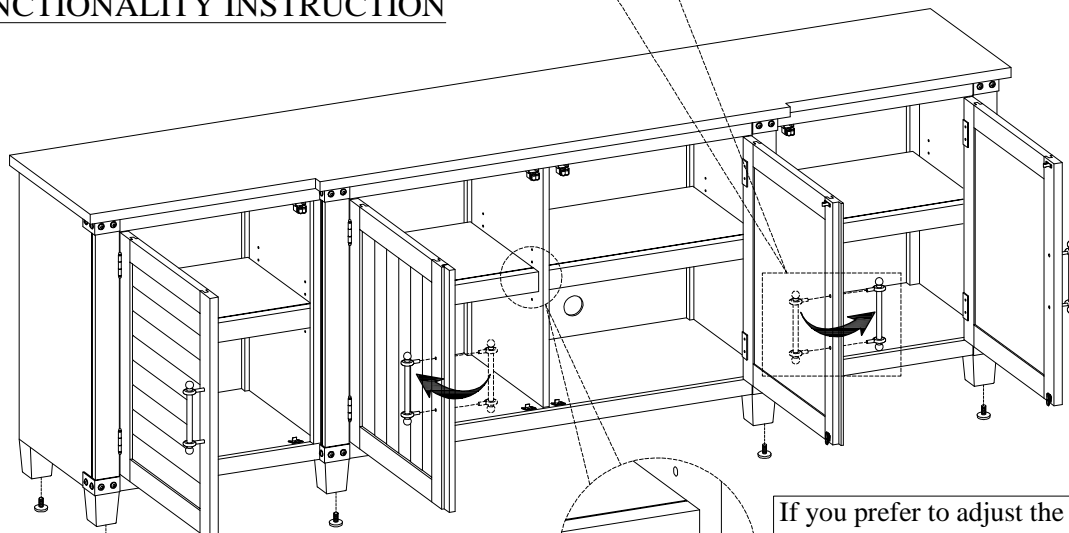

Leveler on Legs & Support Leg
Adjust the leveler when necessary

If you prefer to adjust the shelf location, remove the screws and move shelf brackets to the desired location. Then secure the brackets to shelf with screws.

BEFORE USING THIS PRODUCT PLEASE READ, UNDERSTAND, AND FOLLOW THESE INSTRUCTIONS.
Save these instructions for future reference.

FOR INDOOR USE ONLY